

FLOOD LAMP 12W 3000K BLACK II 2087

Please read instructions before commencing installation and retain for future reference.

SPECIFICATIONS

- **Material:** Aluminium | PC Diffuser
- **Light Source:** LED | 12W | 48V | 3000K | 779Lm | CRI 80
- **Ingress Protection:** IP20 Protection against entry of solid objects greater than 12mm in diameter.

INSTALLATION INSTRUCTIONS

 Electrical products can cause death, injury, or property damage. Maintenance and installation should only be carried out by a professional electrician.

- Ensure the main supply is switched off before connecting to electricity.

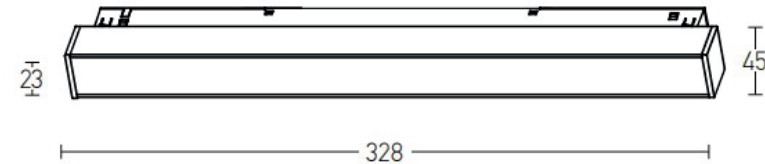
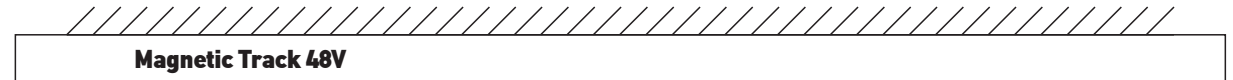
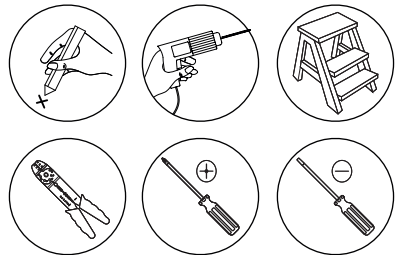

WARNING

 Make sure that the products are installed properly before connecting to electricity.
Do not cover the luminaire.
Do not exceed the maximum wattage rating of the lamp.
If the light source is contained in this luminaire (integrated LED), it shall only be replaced by the manufacturer, his service agent, or a similarly qualified person.



48V MAGNETIC TRACK SYSTEM



Please read instructions before commencing installation and retain for future reference.

WARNING

- Let professional technicians to install. Disconnect circuit before installation.
- The product should be installed away from high temperature flammable.
- Product wiring neat without crossing, should be ground wired.
- When climbing to operate, people should be supervised and anti-slip.

48

VOLT

MAGNETIC SYSTEM

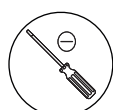

Products structure drawing

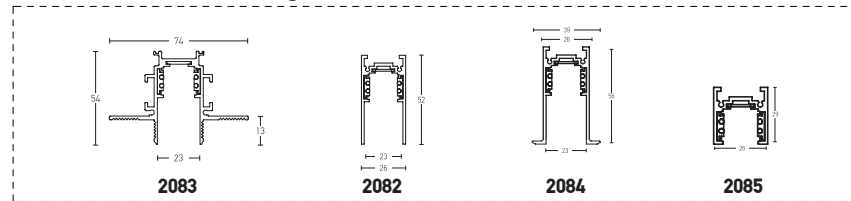

End cap installation instruction

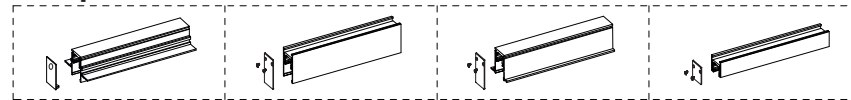

End caps are used to the first and the end track rail. We need fixed it in the track rail and tighten the screws.

Track rail connective instruction

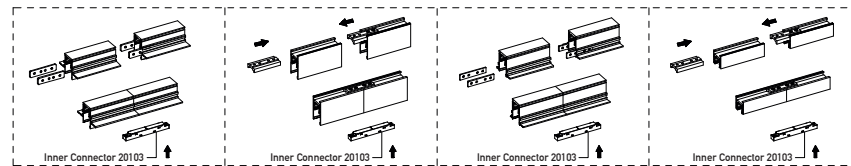

Inner Connector (20103) is used to conductive the line at the junction of two tracks. It is proper to all track rail. Inner Connector is one step to put in.

Horizontal Plane 90° (C2) Connective instruction

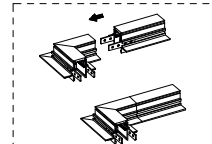

Corner Connector (20104) Connective instruction

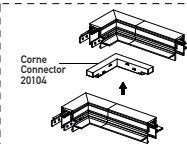

Vertical Plane 90° (C1) Connective instruction

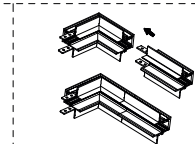

Corner Connector (20104) Connective instruction

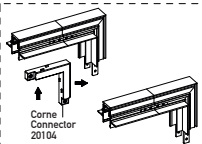

Corners connect with 90° Horizontal (C2) and Vertical (C1) Planes and needs Inner Corner Connector (20104) to conductive the line at the junctions of two tracks. Their installation methods is proper to all tracks rail installation. Corner Connector is on step to put in.

Track rail power on

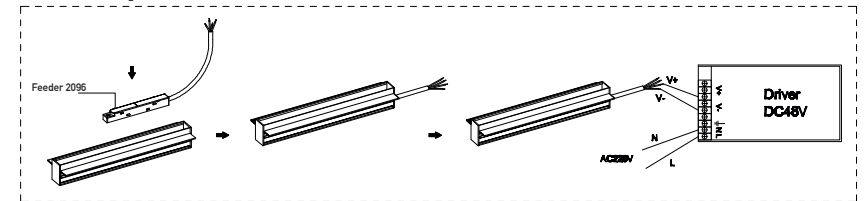

Pendant mounted for surface tracks rail installation instructions

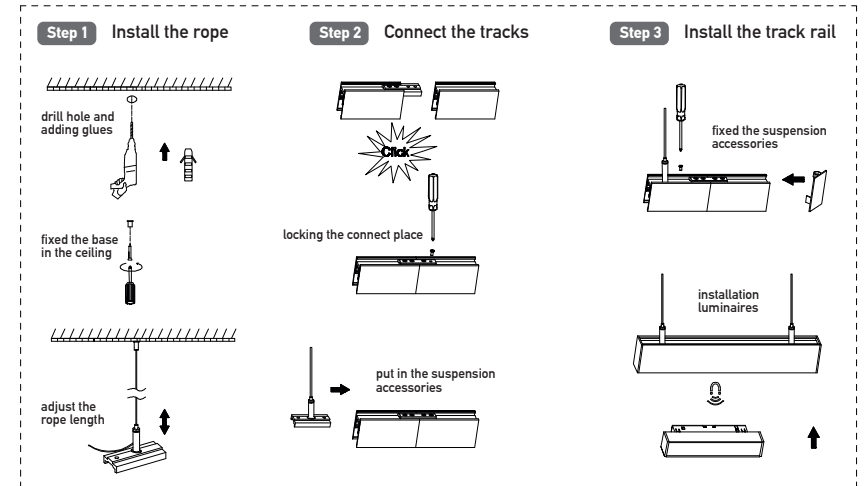

WARNING

- Make sure that the products is installed properly before connecting to electricity.
- Do not cover the fitting.

48V MAGNETIC TRACK SYSTEM



Please read instructions before commencing installation and retain for future reference.

WARNING

- Let professional technicians to install. Disconnect circuit before installation.
- The product should be installed away from high temperature flammable.
- Product wiring neat without crossing, should be ground wired.
- When climbing to operate, people should be supervised and anti-slip.

Recessed Type:

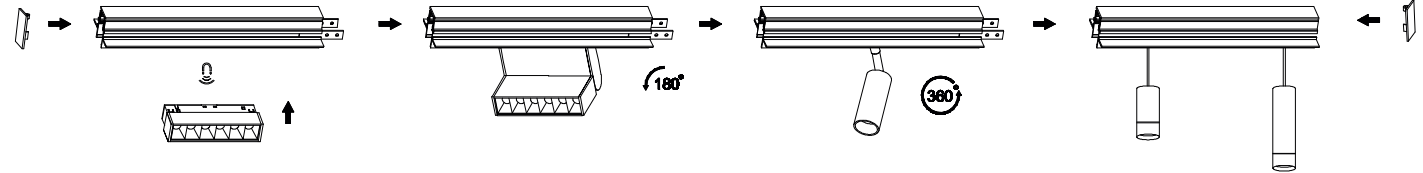

Trimless track rail 2083 installation instruction

step 1.: Pass the profile through the hole as drawing below.

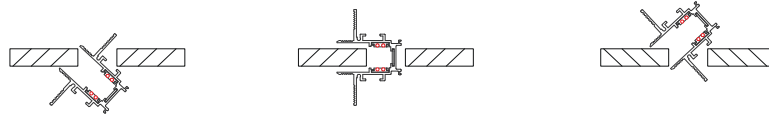

step 2.: Screw from downside with self tapping screws. Important to keep the distance between the profile stable.

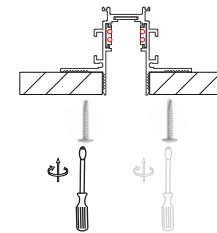

step 4.: Plaster the edge of false ceiling.

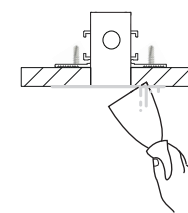

step 3.: Put the end caps to the profile.

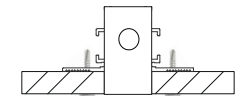

Plastic End Caps.:
Color Black / Code 2099-B
Color White / Code 2099-W

step 5.: Connect the feeder and insert the magnetic luminaire.

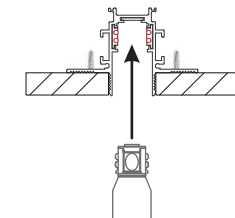

Cutting Hole 28mm

Dimensions Indicated in Millimeters.

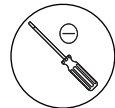
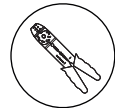
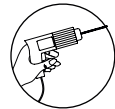
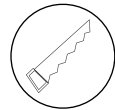
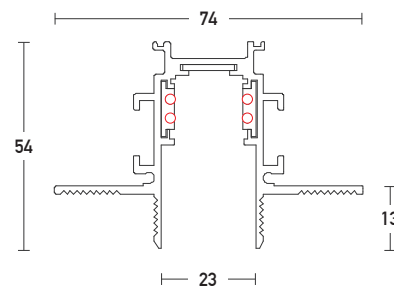

WARNING

- Make sure that the products is installed properly before connecting to electricity.
- Do not cover the fitting.

48V MAGNETIC TRACK SYSTEM



Please read instructions before commencing installation and retain for future reference.

WARNING

- Let professional technicians to install. Disconnect circuit before installation.
- The product should be installed away from high temperature flammable.
- Product wiring neat without crossing, should be ground wired.
- When climbing to operate, people should be supervised and anti-slip.

Recessed Type:

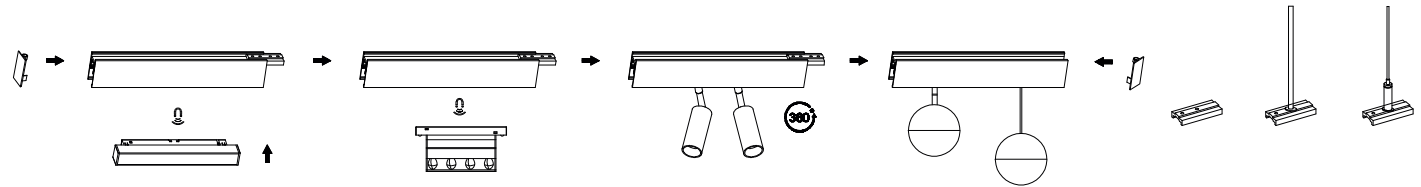

Surface track rail 2082 installation instruction

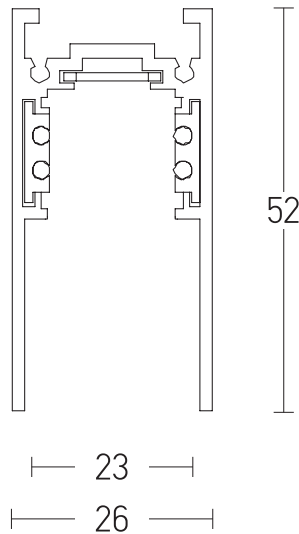
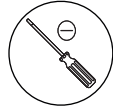
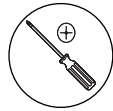
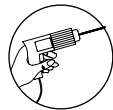

step 1.: The magnetic profile has pre-drilled holes in the top. Touch it on the mounting surface and mark these points.

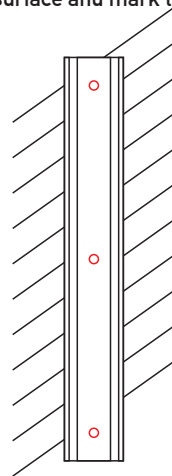

step 2.: Drill the points and insert dowels into mounting surface. Touch profile on the mounting surface and align the holes.

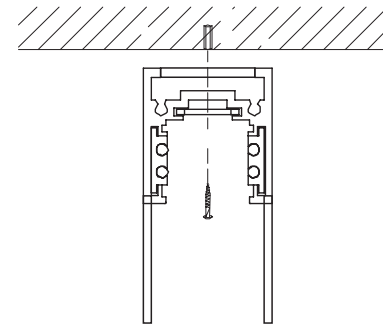

step 3.: Fit magnetic profile onto mounting surface with self-tapping screws.

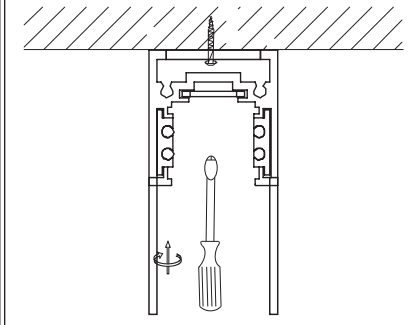

WARNING

- Make sure that the products is installed properly before connecting to electricity.
- Do not cover the fitting.

48V MAGNETIC TRACK SYSTEM



Please read instructions before commencing installation and retain for future reference.

WARNING

- Let professional technicians to install. Disconnect circuit before installation.
- The product should be installed away from high temperature flammable.
- Product wiring neat without crossing, should be ground wired.
- When climbing to operate, people should be supervised and anti-slip.

48
VOLT
MAGNETIC SYSTEM

Recessed track rail 2084 installation instruction

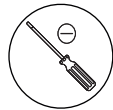
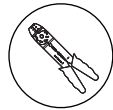

Cutting Hole 29mm

Dimensions Indicated in Millimeters.

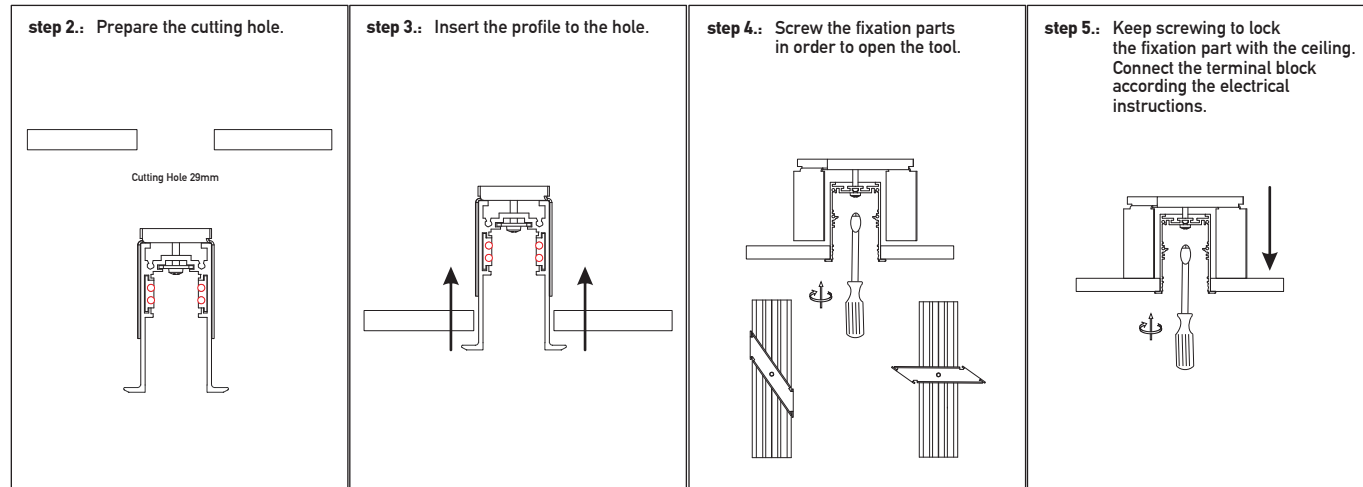
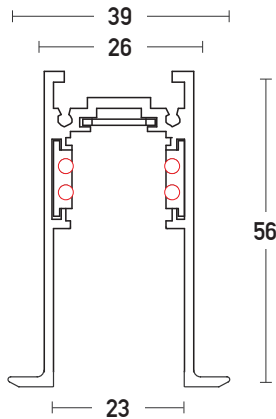

WARNING

- Make sure that the products is installed properly before connecting to electricity.
- Do not cover the fitting.



48V MAGNETIC TRACK SYSTEM



Please read instructions before commencing installation and retain for future reference.

WARNING

- Let professional technicians to install. Disconnect circuit before installation.
- The product should be installed away from high temperature flammable.
- Product wiring neat without crossing, should be ground wired.
- When climbing to operate, people should be supervised and anti-slip.

48
VOLT
MAGNETIC SYSTEM

Surface Short track rail 2085 installation instruction

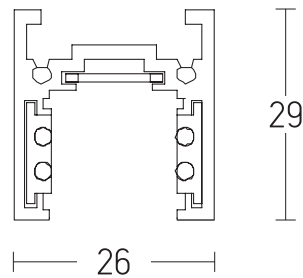
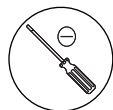
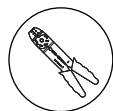
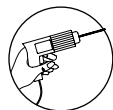

step 1.: The magnetic profile has pre-drilled holes in the top. Touch it on the mounting surface and mark these points.

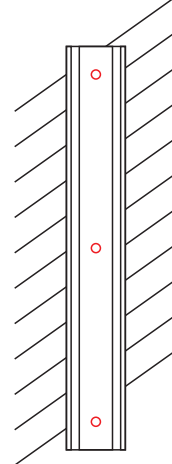

step 2.: Drill the points and insert dowels into mounting surface. Touch profile on the mounting surface and align the holes.

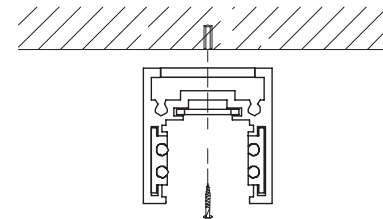

step 3.: Fit magnetic profile onto mounting surface with self-tapping screws.

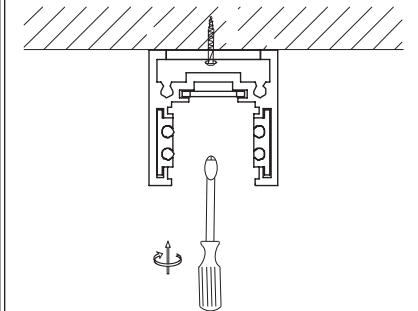

WARNING

- Make sure that the products is installed properly before connecting to electricity.
- Do not cover the fitting.